

inserto in gommapiuma con logo

INSERIRE PANNELLO IN COMPENSATO sp 6mm

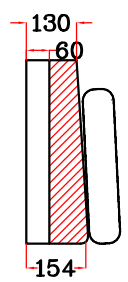

Realizzare n° 2 pezzi

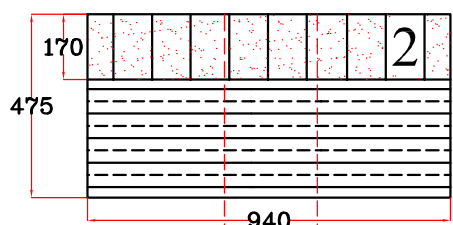
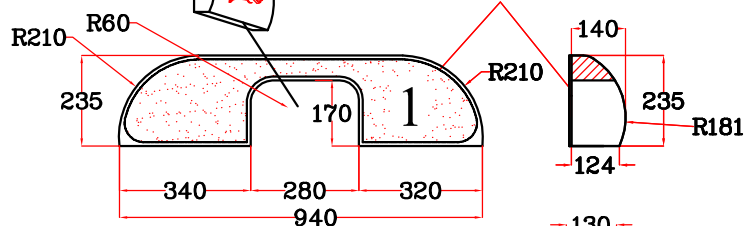
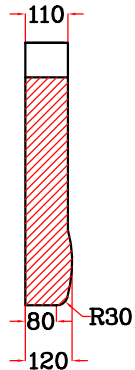
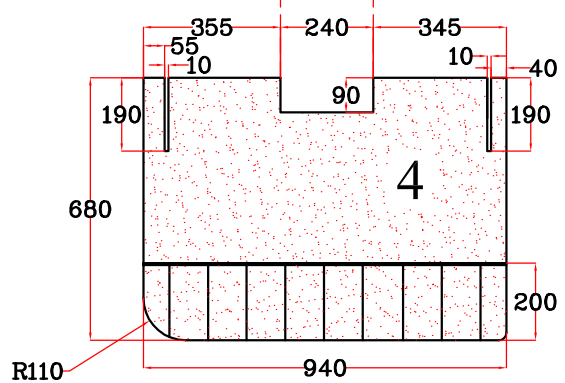
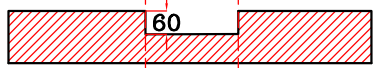
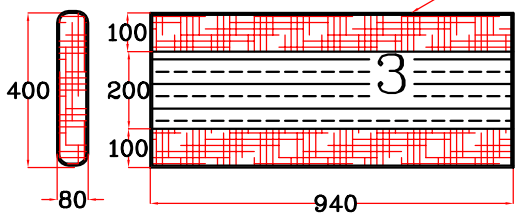

Eseguire i tre jolly A in Pelkò 189 sp. 120mm

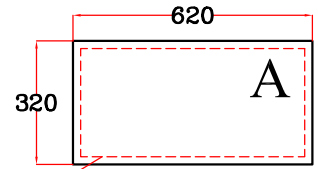

N°2 pannello multistrato togliere lo spessore del pannello alla gommapiuma

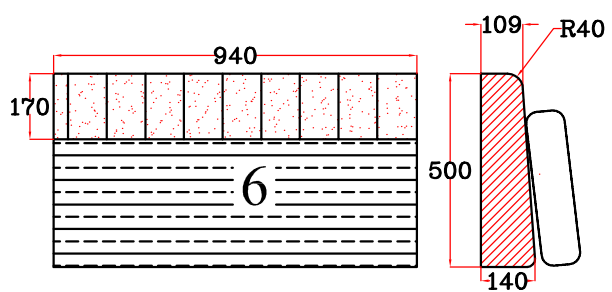
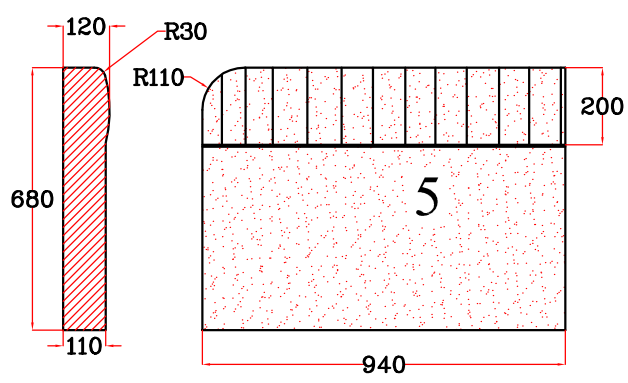

AUTOCARAVANS RIMOR S.P.A. SEDE Via Piemonte n°3 53036 Poggibonsi SIENA ITALY TOLLERANZE DI MASSIMA Grado di precisione medio UNI 5307	PAG 1 di 1	Denominazione Cuscini Super Brig 677 TC	Codice 1TAP090324
		Caratteristiche gommapiuma Densita' 25 Kg/m ³	Caratteristiche gommapiuma schienali Densita' 25 Kg/m ³
Disegnato A.PINZUTI Data 15-10-2015	Approvato A.PINZUTI Data 15-10-2015	Produzione -----	Meccanica RENAULT
Rev -----	MODIFICA -----	NOTE Le dimensioni sono riferite al cuscino finito	Rev 00
Data -----	ESEGUITA -----	Data -----	Data 15-10-2015

I dati e le informazioni contenuti o ricavabili da questo disegno sono di esclusiva proprietà della Autocaravans RIMOR s.p.a. Ogni riproduzione totale o parziale è vietata senza l'autorizzazione scritta della ditta RIMOR s.p.a.